

Country of Origin : China
 Operating Temperature : 0~40 [°C]
 Dimension : 73.8 × 44.3 × 28.8 [mm]
 Certified AC Plugs: EU, UK, USA/Japan/Taiwan, Aus, China, Korea
 Efficiency level (ErP) : VI

Approvals / Marks :



Specifications

Model	Voltage DC [V]	Loading [A]	Max. Power [W]	Ripple / Noise [mV] p-p	Connector [mm]
SYS1001-0505-Wxx*	5	0~1.0	5	150	2.1x5.5x11
SYS1001-0608-Wxx*	7,5	0~0.8	6	150	2.1x5.5x11
SYS1001-0609-Wxx*	9	0~0.66	6	150	2.1x5.5x11
SYS1001-0612-Wxx*	12	0~0.5	6	150	2.1x5.5x11
SYS1001-0615-Wxx*	15	0~0.4	6	200	2.1x5.5x11
SYS1001-0618-Wxx*	18	0~0.33	6	200	2.1x5.5x11
SYS1001-0624-Wxx*	24	0~0.25	6	240	2.1x5.5x11

Features:

Certified plugs Wxx = W2E - Europe | W3U - England | W2 - USA, Canada, Japan, Taiwan | W2A - Australia | W2C - China | W2K - Korea
 Output connector: standard: 2.1 x 5.5 x 11mm or customer requirement | Regulated Output With Low Ripple Noise | Safety Agency Requirements and EMI/EMS Certified
 Private Label Marking Available | Modified and Custom Design Available | 2 Years Warranty

OUTPUT	
Turn delay	3000ms max@AC low line input@output full load
Hold up time	8ms min@AC nominal input@output full load
Efficiency (Normal)	>72%@115v/60HZ,230V/50HZ input & Full load
Transient response (dv,tmax)	0.4V dv max At AC nominal input loading from 20%load to 80% load
	16ms tmax Dynamic rise time 10 us max,duty 40ms max,Dynamic load step is slew rate of 0.5A/us
Power out.Limit	6W
Burn in limit	Full load 2 Hours
Power consumption	0.1W max. At AC nominal input@output min load
INPUT	
Voltage	(90~264)VAC
Frequency	(47~63)hz
Current	0.5A rms@AC low line input and DC output full load
Inrush Surge Current (cold start)	30/40A max@power supply cold start,ambient temperature 25°C @115Vac/230Vac nominal AC input
leakage current	0.25mA Max
PROTECTION	
Over current/ Short protection	The power supply will be auto recovered when over current or short circuit faults remove (fold back). Is defined as any output impedance of less than 0.1Ω. The power supply will be auto recovered when short circuit faults remove
Over Voltage	The power supply will not be auto recovered when faults remove 110%-150%. (Voltage limit)
Input protection	F1 1A/250V Fuse The power supply shall be protected against power line surges and any abnormal condition
No Load protection	The power supply is provided with no load operation to prevent the power supply and system from damage.
Protection class	II

EMC	
EMI	EN 55022 Class B (2006)+A1(2007) EN 61000-3-2(2006)+A1 (2009)+A2 Class A(2009) EN 61000-3-3(2008)
EMS	EN55024(1998)+A1(2001)+A2(2003) IEC 61000-4-2(2008) IEC 61000-4-3(2006)+A1(2007)+A2(2010) IEC 61000-4-4 (2004)+A1(2010) IEC 61000-4-5(2005) IEC 61000-4-6(2008) IEC 61000-4-8(2009) IEC 61000-4-11(2004)
SAFETY	
cUL FCC GS CE CB RCM EAC BSMI PSE CCC VCCI	
OTHERS	
Dielectric Strength (Hi-pot)	I/P-O/P:3000VAC
M.T.B.F	500,000 Calculated Hours at 25°C, according to the MIL-HDBK-217F
Cable Length	1370mm (4.5 feet) standard cable or as required
PLD (power line disturbance)	Line power surge Line voltage SAG-more info on request
Cooling method	Natural Convection Cooling
Housing material	PC + ABS
Temperature coefficient:	<±0.5%/°C
ENVIRONMENT	
Temperature	Operating: 0~40°C / Storage: -20~-85°C
Humidity	Operating: 8%~90%RH / Storage: 5%~95% RH non condensing
WEIGHT	
NW: 80g/pc + plug	
GW:95g/pc + plug	
PACKING	
Box	100 pcs/1 box

Mechanical case specification:

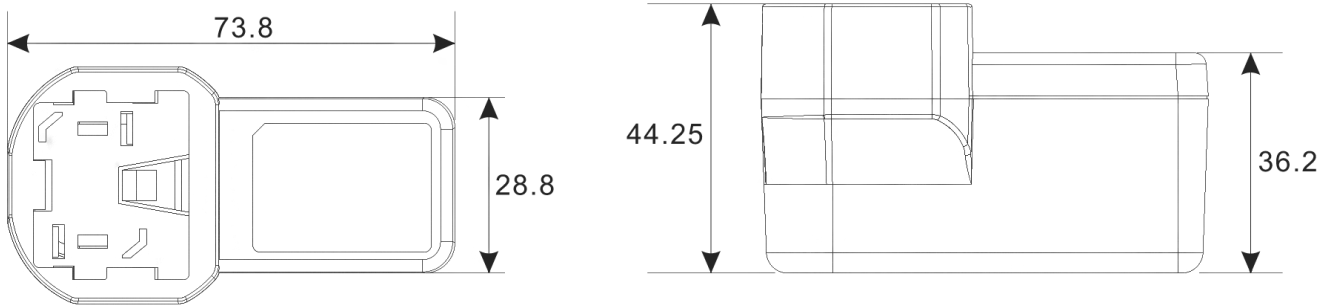

Mechanical specification (country housing):

US / Japan type (W2)

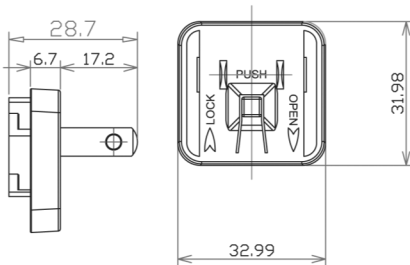

UK type (W3U)

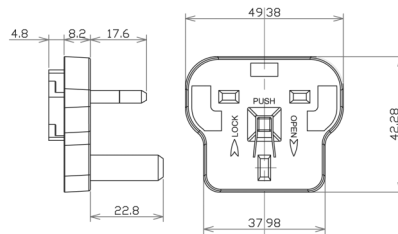

Europe type (W2E)

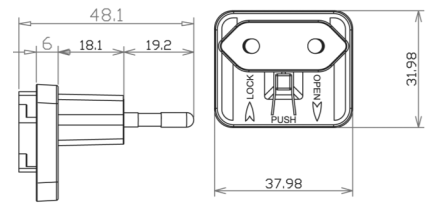

Australia type (W2A)

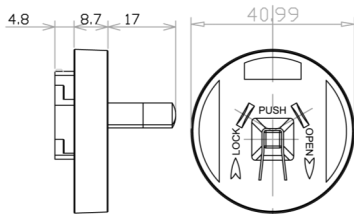

China type (W2C)

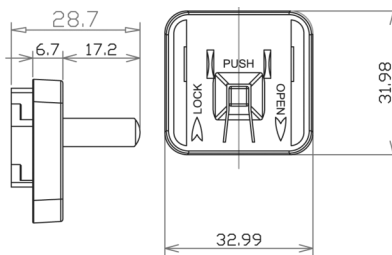

Korea type (W2K)

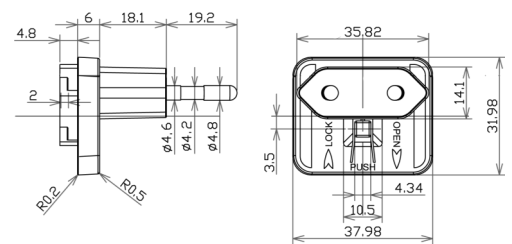

Cable specification:

